

Balcony Energy Storage System User Manual

AE-FS2.0-2H2

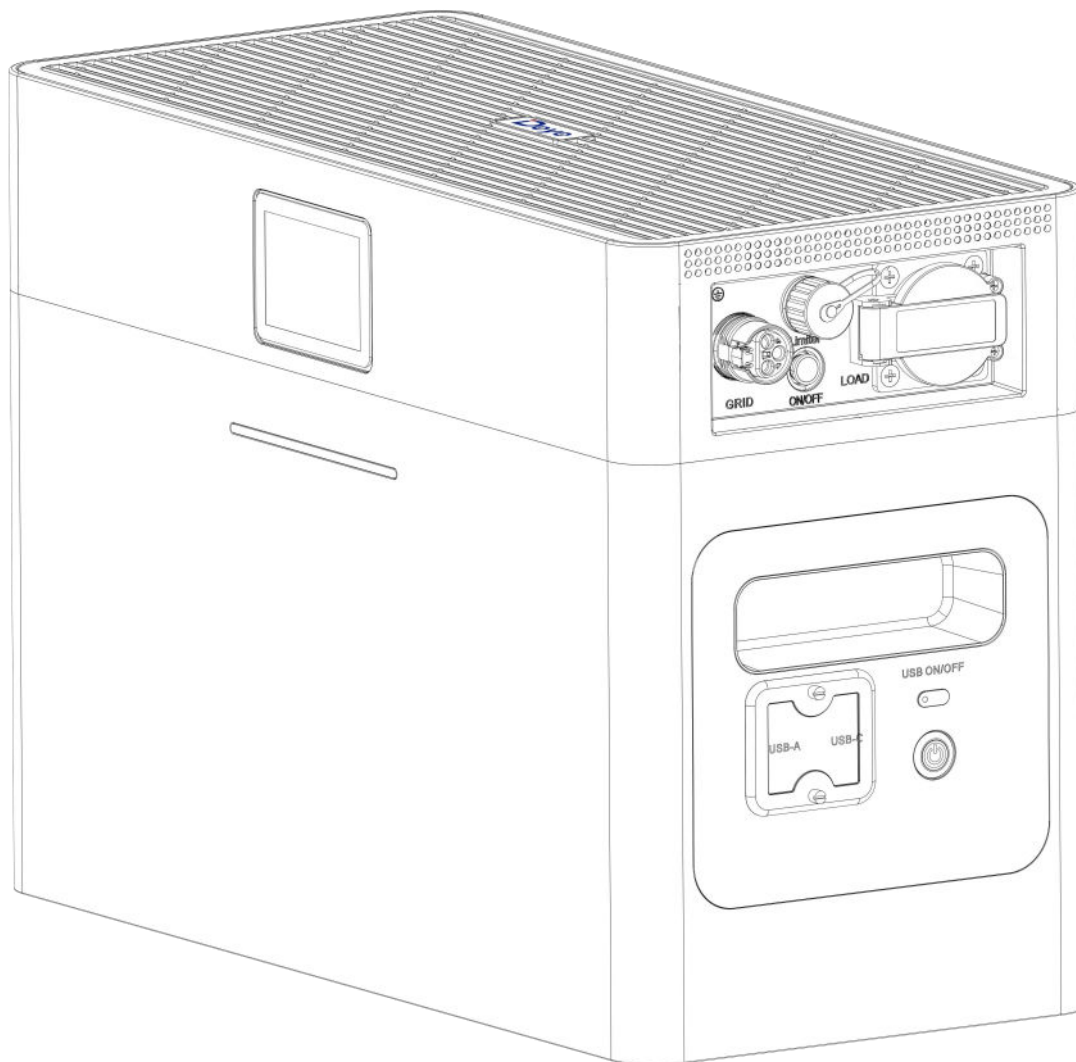

Contents

1. Product Introduction	2
2. Parameters and Specifications	2
3. Packing List	3
4. Safety Precautions	4
4.1 Preparations before Connecting	4
4.2 Safety Precautions during Use	4
5. Quick Guide	5
5.1 Product Appearance	5
5.2 Introduction to Display Screen Icons	6
5.3 Application Scenarios	6
6. Instructions for Connections of the Product	7
6.1 LOAD port	7
6.2 PV port for DC input	8
6.3 GRID Port for AC Input	9
6.4 CT Port for DC input	11
6.5 BAT Port for DC input	12
6.6 USB Port for DC Output	12
6.7 System Diagram	13
6.8 System Working Mode	14
6.9 Power On/Off	14
7. Using the APP	16
7.1 Login	16
7.2 Create A Plant	17
7.3 Adding Collector	17
7.4 Configuration of the Network	18
8. Use of the Extender Battery Module	24
8.1 Parameters and Specifications of the Extender Battery module	24
8.2 Connection Method for AE-F2.0	24
8.3 Precautions during Use	24
9. FAQ	26
10. Common Faults and Troubleshooting Methods	27
11. After-sales Service	31

1. Product Introduction

The DEYE1000/1000W Balcony Energy Storage System features built-in lithium iron phosphate battery cells and various functions including AC grid-connected charging/discharging, off-grid power supply (UPS) applications, direct digital devices charging via USB ports, 2200W PV power charging, and battery capacity expansion up to 10kWh. Real-time monitoring of the power status is possible either locally via a touch screen, or remotely via an app. It is an optimal solution for balcony PV energy storage and portable outdoor power supplies.

2. Parameters and Specifications

Model	AE-FS2.0-2H2
AC Technical Specification	
Nominal Input/Output Power/UPS Power	1000/1000W
AC Inoput/Output Frequency and Voltage	50Hz(45Hz-55Hz),L/N(PE),220/230 Vac
Grid type	Single phase
Rated Grid input/output Current	4.6A/4.4A
Max.Grid input/output Current	5.0A/4.8A
Peak Power(off grid)	2 time of rated power,10s
Power Factor Adjustment Range	0.8 leading to 0.8 lagging
MAX. bypass (Grid to load)	10A
DC injection current	THD<3%(Linear load<1.5%) mA
DC Technical Specification	
Max.PV Input Power	2200W
Max.PV Input Current	18A+18A
Max.PV Short-circuit Current	27A+27A
Rated PV Input Voltage	42.5V(20V~55V)
Start Up DC Voltage	25Vdc
MPPT Voltage Range	20~55V
Number of MPPT	2
Battery Chemistry	LiFePO ₄
Battery Nominal Voltage	51.2V
Battery Nominal Energy	2000Wh
Battery Operating Voltage	44.8V-57.6V
Battery Cycle Life	≥6,000(@25℃±2℃,0.5C/0.5C,70%EOL)

Other Technical Specification	
Display	LCD & APP
Communication interfaces	Wifi, Bluetooth
Dimension(W × D × H)	450 × 210 × 321mm
Weight Appr.	26kg
Operating Temperature Range	-10℃ ~ 50℃
Max.operating altitude	3000m
Relative Humidity	15% ~ 85% (No Condensing)
Safety EMC/Standard	IEC62619, UN38.3, IEC/EN 62109-1, IEC/EN 62109-2, IEC/EN 61000-6-1, IEC/EN 61000-6-2, IEC/EN 61000-6-3, IEC/EN 61000-6-4
Grid Regulation	VDE4105, IEC61727/62116, VDE0126, AS4777.2, CEI 0 21, EN50549-1, G98, G99, C10-11, UNE217002, NBR16149/NBR16150
Battery Certification	UN38.3, IEC62619
Installation Style	Floor-Mounted

3. Packing List

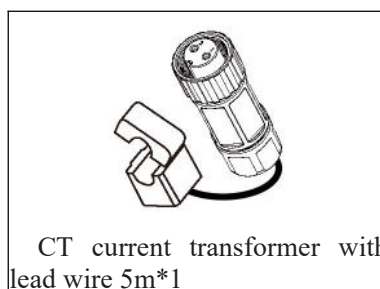
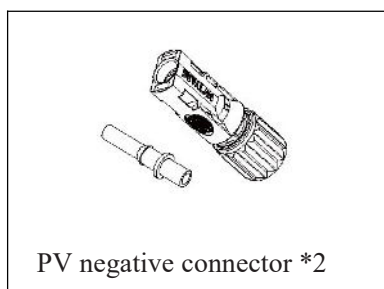
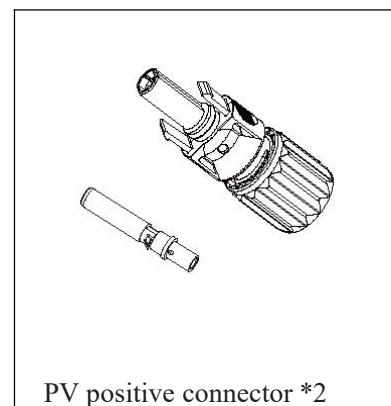
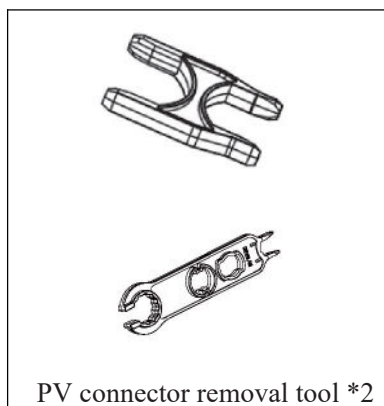

4. Safety Precautions



Reminder

1. It is crucial and necessary to carefully read the User Manual (provided in the Appendix) before installing or using the battery. Failure to do so, not following any instructions or ignoring any warnings in this document may result in electric shock, serious injury, or damage to the battery, rendering the product non-functional.
2. If the battery is to be stored long-term, it is recommended that the product be charged once every month, ensuring that the State Of Charge (SOC) remains above 50%.
3. The battery should be recharged within the next 48 hours after being fully discharged.
4. Do not expose the cables to external elements.
5. All power sources must be disconnected before and during maintenance.
6. In case of any abnormalities, please contact the supplier within 24 hours.
7. Do not use cleaning solvents to clean the battery.
8. Do not expose the product to flammable or corrosive chemicals or vapors.
9. Do not paint any part of this product, including internal or external components.
10. Direct or indirect damage resulted from the above circumstances are not covered by the warranty.
11. Do not insert any foreign objects into any part of the battery.



Warning

4.1 Preparations before Connecting

1. After unpacking, please check the battery and the packing list first. If the battery is damaged or missing any parts, please contact the local retailer.
2. Before installation, make sure to cut off the grid power supply and ensure the battery is turned off.
3. The connections must be correct, and there must be no short circuiting with external devices.
4. Keep away from any ignition sources.
5. Do not use parts or accessories that are not provided by the official supplier.
6. Do not stack heavy objects on top of the battery.

4.2 Safety Precautions during Use

1. To move or repair the battery, please disconnect the power supply and fully turn it off first.
2. Do not connect the battery with other batteries of different models.
3. Do not remove any part of the battery.
4. In case of a fire, only liquid fire extinguishers should be used; dry fire extinguishers are prohibited.

5. Quick Guide

5.1 Product Appearance

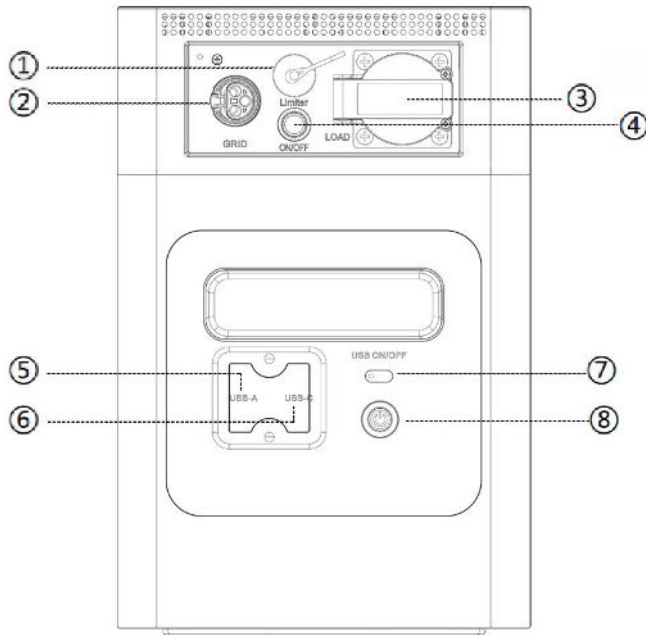

- ① CT interface
- ② Grid Interface
- ③ LOAD Interface
- ④ Main switch of AC output
- ⑤ USB-A output port *2
- ⑥ USB-C output port *2
- ⑦ USB output power switch
- ⑧ Main power switch

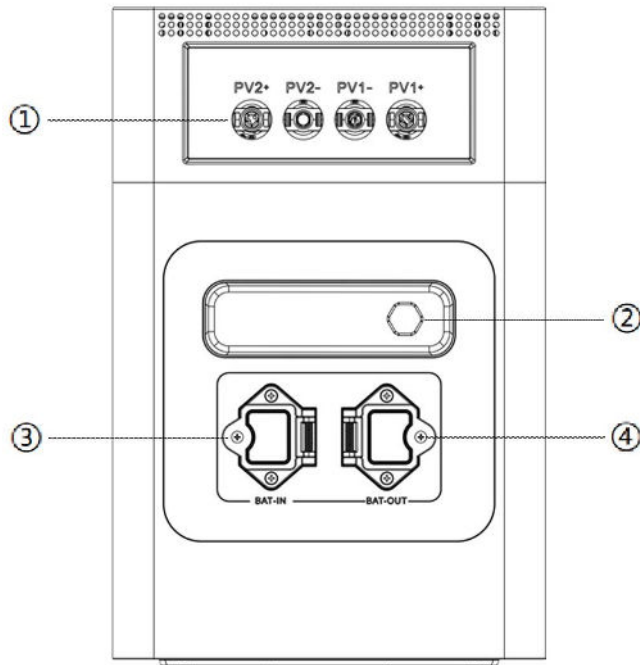

- ① PV input port
- ② Air vent valve
- ③ Battery expansion input port
- ④ Battery expansion output port

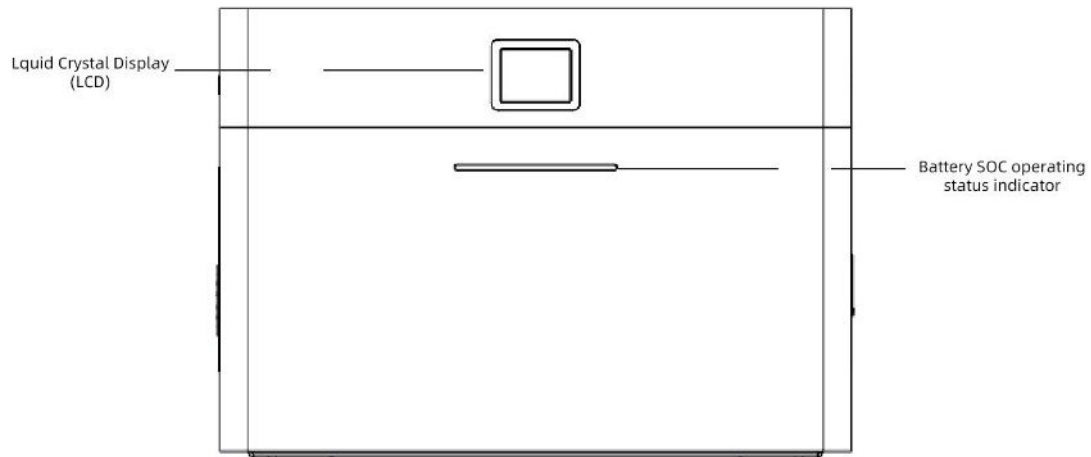

5.2 Introduction to Display Screen Icons

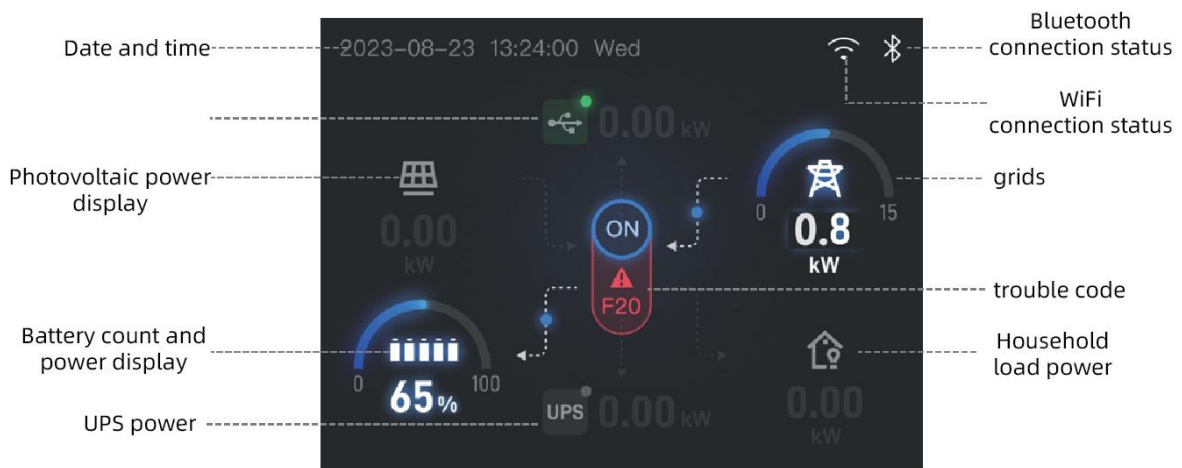

5.3 Application Scenarios

The battery offers solutions for both household energy storage systems and portable outdoor power supplies.

The household energy storage systems can either come with PV charging or without it.

For the system with PV charging, the UPS port is connected to the grid, and the PV port is connected to the PV power source. The battery functions as a hybrid energy storage system. Please refer to Sections 6.2 and 6.3 for connection instructions.

For the system without PV charging, the UPS port is connected to the grid, and the battery is an energy storage device for a small-scale PCS. See Section 6.2 for connection instructions.

When the battery is used as a portable outdoor power supply, it provides power to digital devices and appliances. PV panels can be connected to the battery for outdoor use as well, should it be necessary. Refer to Section 6.1 for connection instructions for the above uses.

6. Instructions for Connections of the Product

6.1 LOAD port

1. First, make sure that the battery is turned off.
2. Use a screwdriver to unscrew the load interface protection cover as shown below.
3. Open the protective cover of the load interface, insert the plug of the appliance to be used into the interface, make sure the connection is tight.
4. After confirming the correct connections, press the main power switch. Wait for the indicator lights to display. Press the main switch of AC output. Wait for the LCD screen to light up. Then, the device will run a diagnostic test. The system is running normally if there is no faults or alarm.
5. Check the screen display, if the display is normal, the connection is successful and power is successfully supplied to the appliance.

Note: *The default standby time for the AC output port is 5 minutes. If there is no load connected to the AC output port for over 5 minutes, it will shut off automatically.

* When not using the AC output, please promptly turn off the AC output switch to avoid power loss to the inverter.

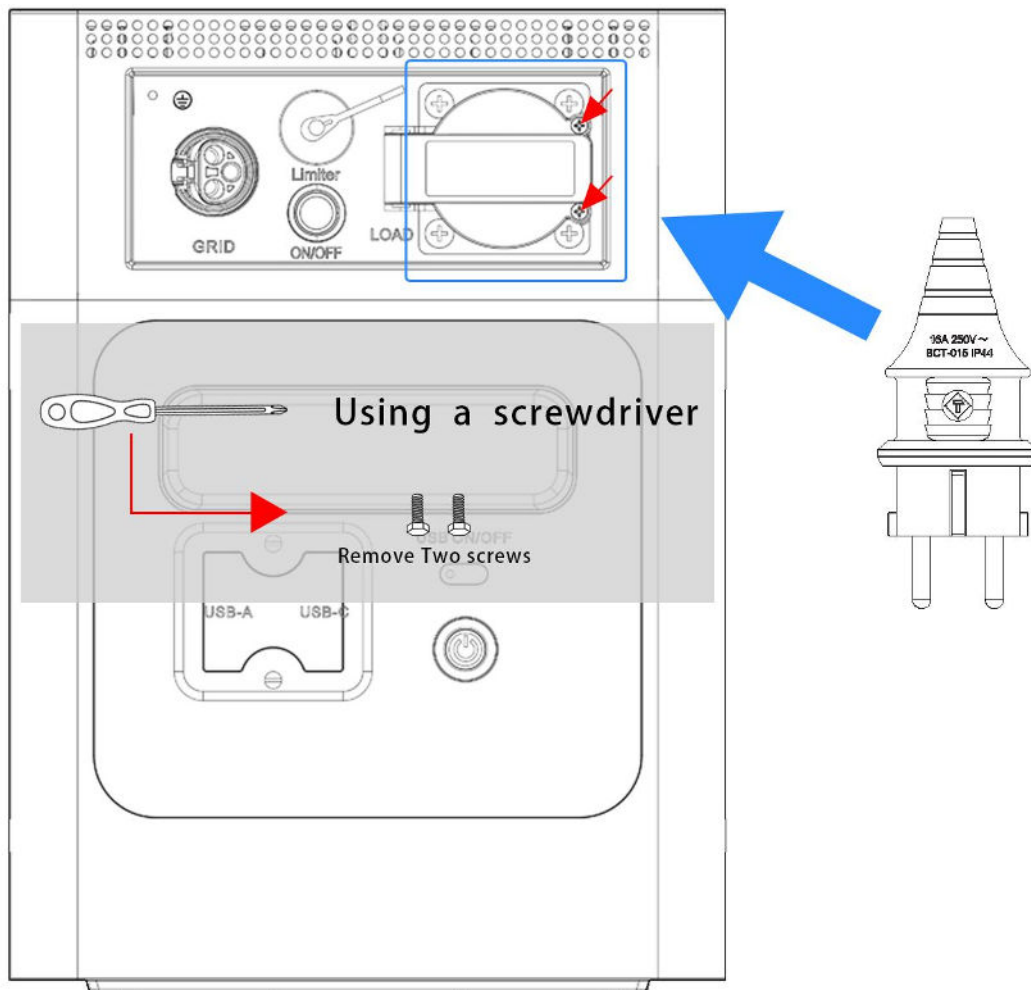

6.2 PV port for DC input

Before charging the battery, make sure the PV port is correctly connected to the PV power source. Turn on the main power switch of the battery pack, then the inverter power switch. The LCD screen will light up, and the battery will run a diagnostic test. If there is no faults or alarm, the system is operating normally, and the setup is successful.

Please refer to the following parameters when selecting a suitable PV power source:

1. The max. open-circuit voltage (Voc) of the PV module should not exceed 60V (upper limit of the inverter).
2. The min. open-circuit voltage (Voc) of the PV module should be higher than 25V (min. Startup voltage of the inverter).
3. Input voltage range: 20V - 60V.

Inverter model	AE-FS2.0-2H2
PV Input Voltage	25V (25V-60V)
PV Array MPPT Voltage Range	20V-55V
No. of MPP Trackers	2
No. of Strings per MPP Tracker	1+1

6.2.1 Connections of PV Modules:

1. Turn off the main grid power switch (AC).
2. Install the PV input connector onto the inverter.





Safety Instructions:
Please use DC cables that meet the requirements for PV use.

Type of Cable	Cross Section (mm ²)	
	Range	Recommended Value
Specialized PV DC cable (model: PV1-F)	2.5-4.0 (12-10AWG)	2.5(12AWG)

Common Cable Specifications

The steps to install the DC connectors are as follows:

- a) Strip the outer sheath off the DC wire by approximately 7 millimeters, then remove the connector's locking nut.

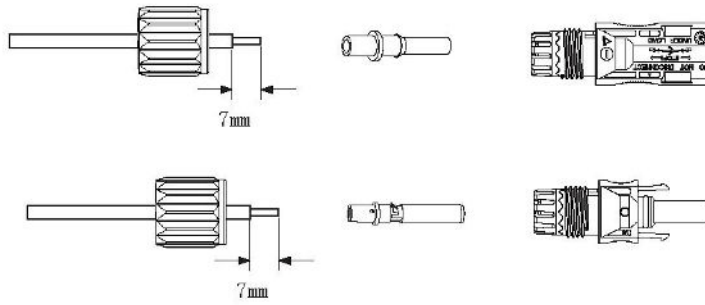

Removal of the Connector's locking nut

b) Use a crimping tool to crimp the metal terminal.

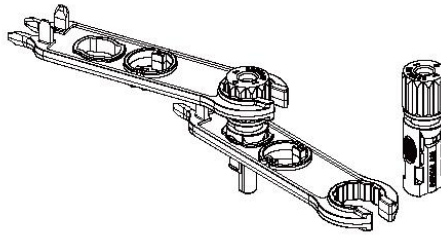

Crimping the Terminal onto the Wire

c) Insert the crimped terminal through the locking nut into the top of the connector, then tighten the locking nut back onto the connector.

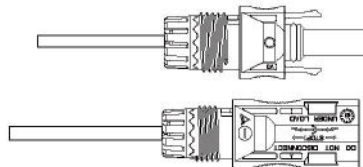

Connector (with the locking nut already tightened)

d) Finally, insert the DC connectors into the positive/ negative input ends of the inverter.

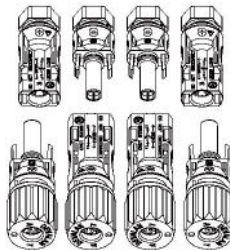

Connections of DC Input Ends

6.3 GRID Port for AC Input

After the DC connectors have been connected, do not close the DC switch (leaving it open-circuit). Connect the AC connectors to the inverter's AC input port, which is equipped with the single-phase AC terminal for easy connection. It is recommended to use flexible wires for ease of installation. Specifications are shown in the table below.



Warning:

It is prohibited to use a single circuit breaker for multiple inverters and to connect any load between adjacent inverter circuit breakers.

Model	Cross-sectional Area of the Cable	Circuit Breaker	AWG	Maximum Cable Length
AE-FS2.0-2H2	1.5mm	20A/400V	14	External cable (L+N+PE)20m

Cable Information

The AC output connector is divided into three parts: a socket, a sleeve, a sealing ring, and a locking nut. The connection steps are as follows:

Step 1: Remove the sealing ring and the sleeve from the AC connector in turn.

Step 2: As shown in Figure 5.7, separate the sleeve from the socket. There are two locking holes on the connector body. Press the locking valve inward to separate the socket and the sleeve.

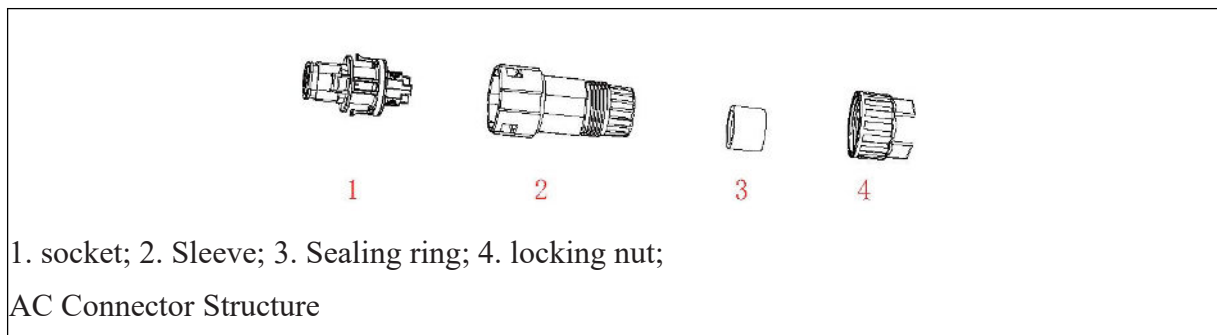

Step 3: To prepare the AC cable, use a wire stripper to strip off the outer sheath for about 40mm and the insulation of each conductor for about 8-15 mm, as shown in the figure below.

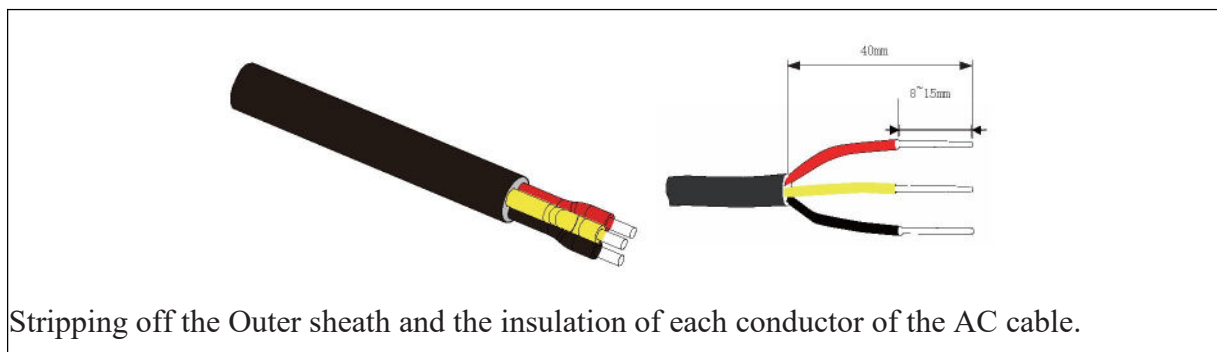

Stripping off the Outer sheath and the insulation of each conductor of the AC cable.



Warning:

Please pay attention to differentiate between the L, N, and PE conductors of the AC cable

Step 4: Run the L, N, and PE conductors of the cable through the locking nut, the sealing ring, and the sleeve. Pay attention to follow that particular order and the orientation of the parts.

Step 5: Use a hexagonal screwdriver to loosen the socket bolts, then insert each conductor into the corresponding hole, and tighten all bolts. The orientation of the conductors in the AC connector is shown in the diagram below.

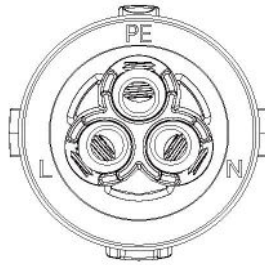

The orientation of the conductos for the AC Connector

Step 6: Slide the sealing ring and the sleeve along the conductors until the sleeve clicks into the socket. Make sure the sealing ring is tightly fit into the sleeve around the conductors and then tighten the locking bolt. The AC connector is ready for use.

Step 7: Plug in the AC connector into the AC input port of the battery. Prior to charging the battery, ensure the GRID port is correctly connected to the mains power supply. Start by turning on the battery pack power switch, then turn on the inverter power switch. The LCD screen will light up, indicating that the device has started running the diagnostic test. If there is no faults or alarm, the system is operating normally, and the battery can be charged through the mains power supply.

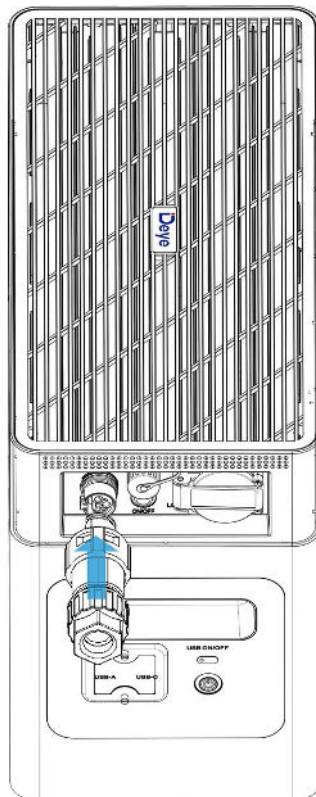

Connection for the AC Input port

6.4 CT Port for DC input

If you are currently running the inverter and wish to activate the anti-backflow function, please turn off the inverter's AC and DC switches, and wait for 5 minutes until the inverter is completely discharged. Then connect the current sensor output to the CT port on the inverter. Make sure the connection is secured, and clamp the current sensor onto the L phase of the mains power supply. In order to provide more insights into the use of the built-in anti-backflow function of the inverter, we have provided a wiring diagram as shown below. The red wire

connected to the grid supply represents the L phase, the blue wire represents the neutral N phase, and the green-yellow wire represents the ground wire (PE). We recommend installing an AC switch between the inverter AC input port and the grid supply. The specifications of the AC switch should be determined based on the load capacity.

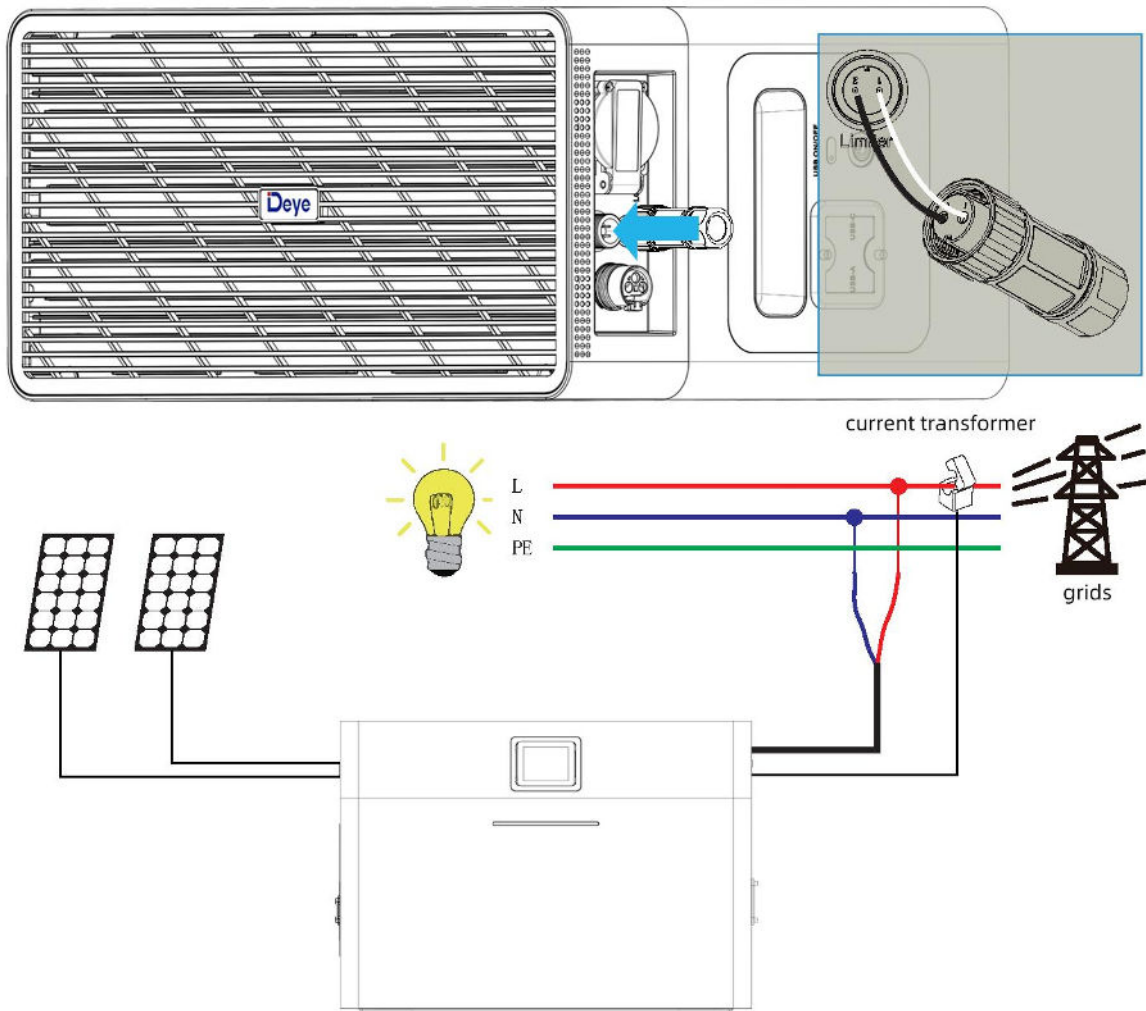

6.5 BAT Port for DC input

The balcony energy storage system is equipped with an expansion interface to support up to 4 battery packs in parallel.

When multiple battery modules in parallel are used as an energy storage system. Use a series connection cable to connect the BATOUT port of the first battery module and the BATIN port of the next battery module, and so on and so forth until the BATIN port of the last battery module is connected. Parallel operation of up to five battery modules is possible.

6.6 USB Port for DC Output

Turn on the battery pack power switch, the LED light will lit up. Then turn on the inverter power switch, and short press the USB ON/OFF button to activate the DC output. At this point, the USB-A/USB-C ports will start functioning, allowing users to connect devices such as mobile phones.

Note: After the DC output is actively discharging into a load, the battery will not shut down automatically. You need to manually turn off the DC output.

If there is no load connected to the DC output within ten minutes, the battery will automatically

shut down.

If water enters the USB port, use a dry tissue to absorb the water. After drying it, the device can be used normally. Failure to do so may cause it to malfunction but will not damage the USB port.



Warning:

Do not insert other chargers into the USB port, as the port could be damaged.

6.7 System Diagram

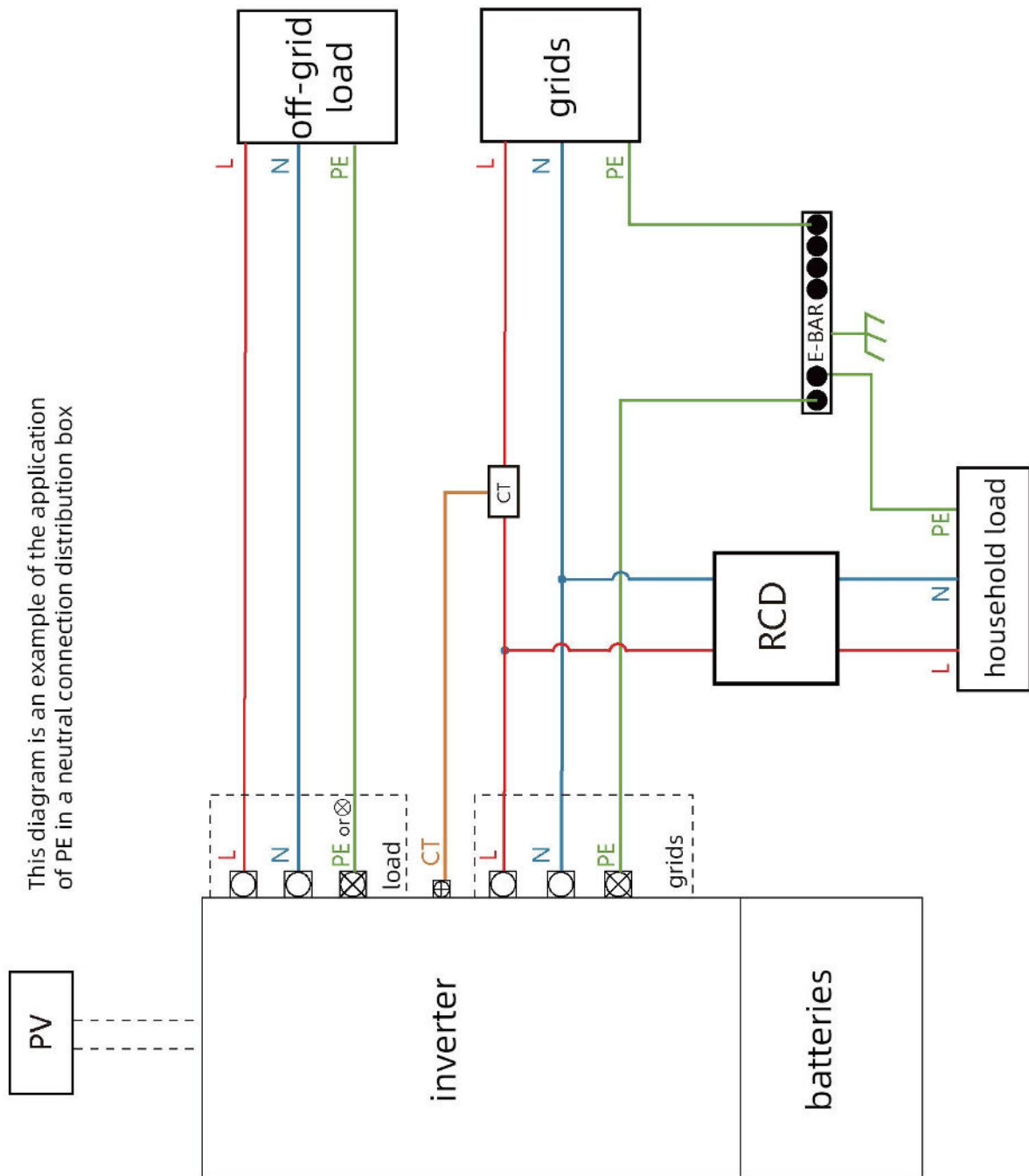

6.8 System Working Mode

Grid-connected mode: After the grid port is connected, the battery module and the connected PV power source can supply energy to the grid. The energy transfer logic can be configured, and it is also possible to set the grid supply and the connected PV power source to charge the battery module.

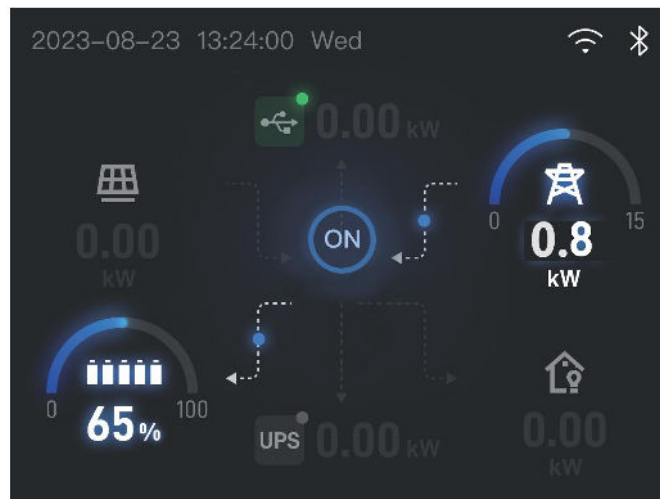

Off-grid mode: When the grid port is not connected, the inverter automatically switches to the off-grid mode and supplies the connected load with the PV power source and the battery module. It prioritizes using PV power, supplementing with the battery module when needed. Excess PV power, when available, is used to charge the battery module.

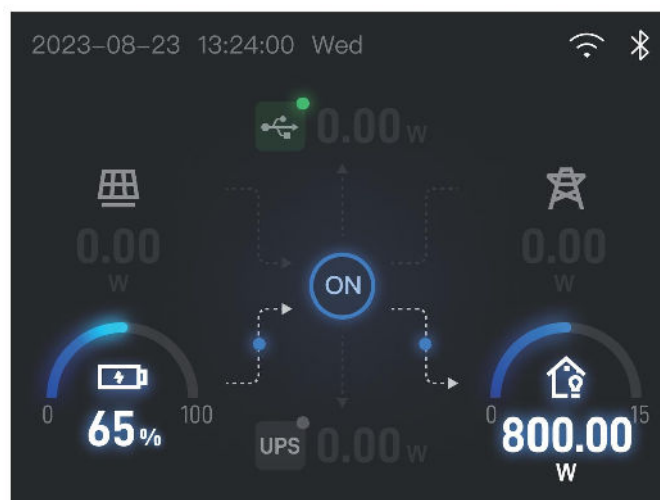

6.9 Power On/Off

Power On, Power Off and LCD Screen Lighting Up

Press the battery module power switch, and the LED indicator lights up. Then press the inverter power switch to turn on the inverter, and the LCD screen lights up. Short press the USB ON/OFF button to activate the USB DC output port. When there is no operation or load change to the battery for a set period of time (time period can be set via the APP), the LCD screen will automatically dim. When there is a load change or operation to the battery, the LCD screen will be automatically lit up.

When the battery is active, press the inverter power switch, then press the battery USB ON/OFF button, and finally press the battery power switch to power off.

Note: *The battery has a default standby time of 5 minutes after being turned on. If other output

power switches are not turned on and there is no load connected, the battery will automatically shut down after 5 minutes. The standby time can be set in the APP.

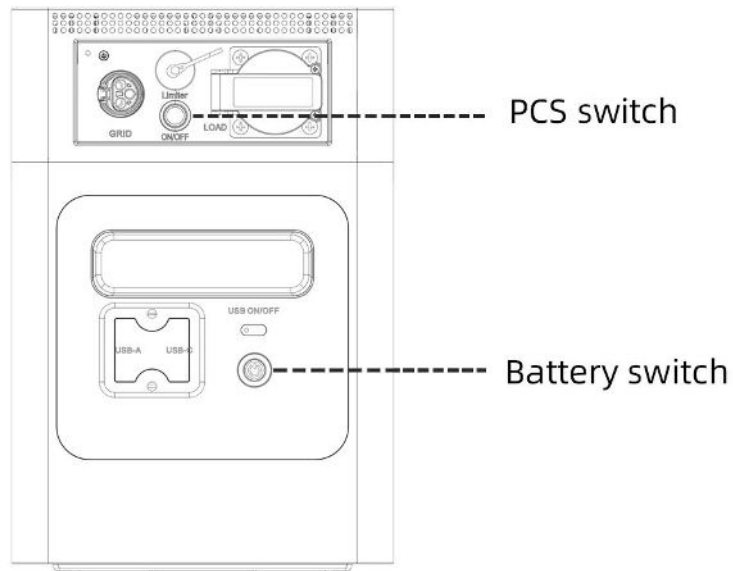

7. Using the APP

You can control and monitor the battery through the Deyecloud APP or the website www.deyecloud.com. Download the Deyecloud APP by scanning the QR code below.



7.1 Login

On the login page, you can choose to log in with email, phone number, or username. Enter the corresponding account information and click "Login".

Note: Only accounts registered with usernames in the old version support logging in with usernames.

Step 1: Phone number login — log in with password or verification code.

Step 2: Click on the icon at the bottom of the page to switch to email login or username login.

Step 3: Check [I have read and agreed to the *Service Agreement/Privacy Policy*] and click [Login].

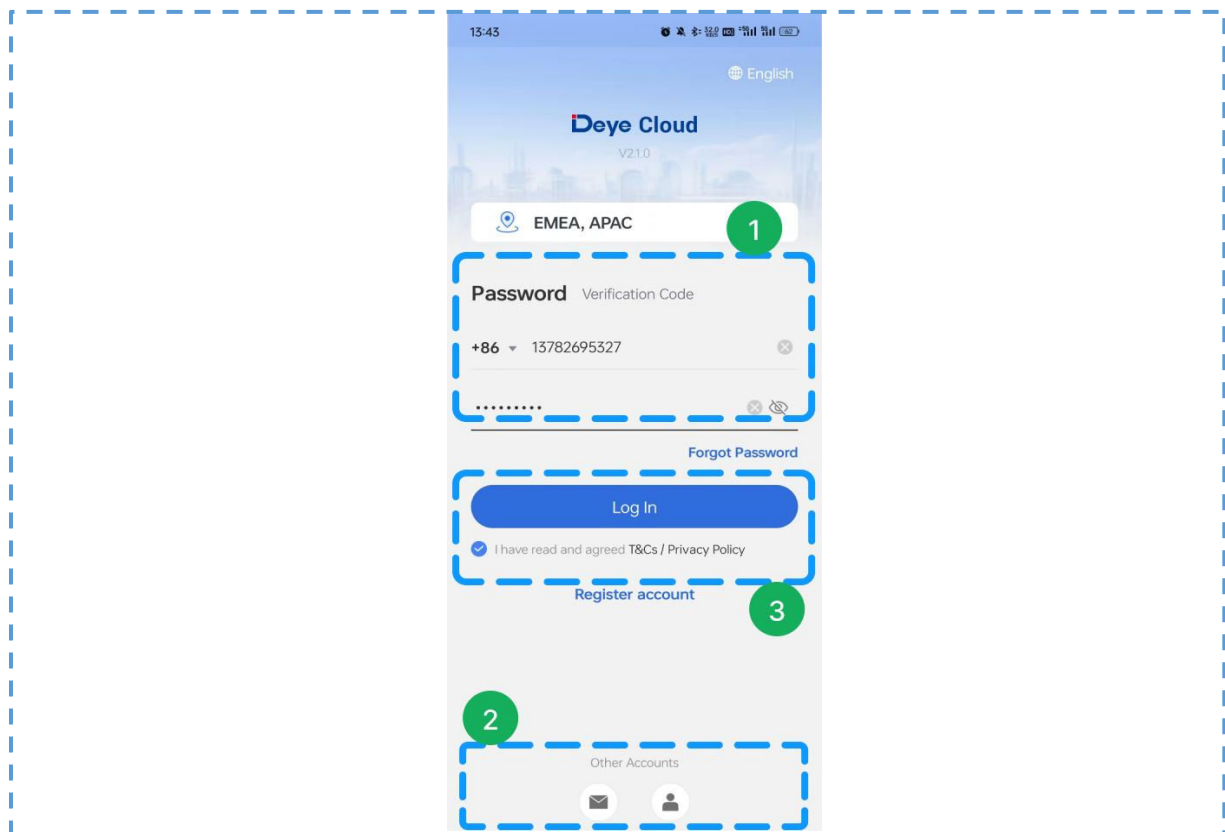

7.2 Create A Plant

Step 1: Click on the top right corner of the plant page and select [Create A Plant].

Step 2: After filling in the relevant information about the plant, click [Confirm].

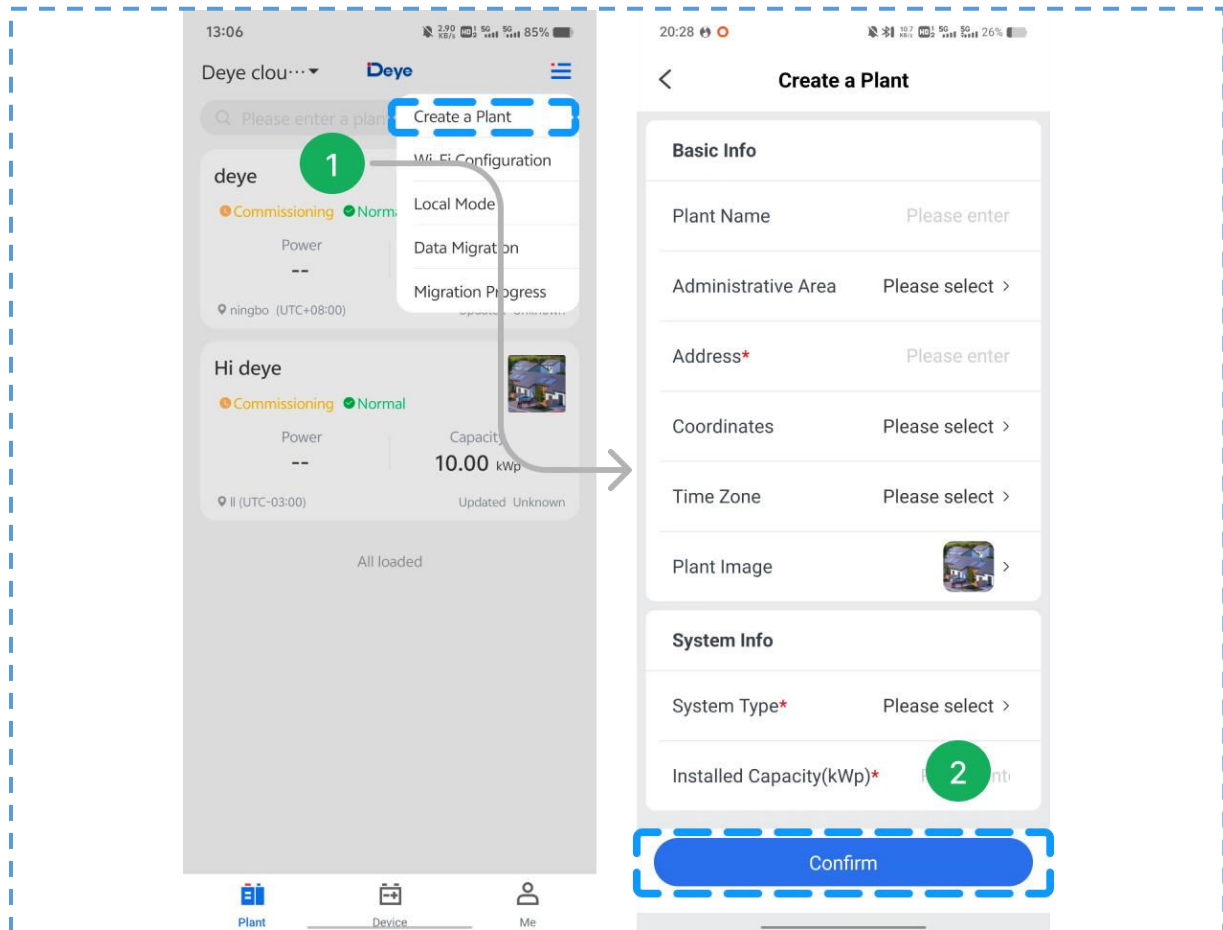

Note: Please select the correct grid connection type. For string inverters and micro-inverters, select the grid connection system; for energy storage inverters, choose the energy storage system.

7.3 Adding Collector

Method 1: After successfully creating the plant, click [Add Now] directly in the pop-up window.

Method 2: Go to the plant details page, click the drop-down menu in the top right corner, and then click [Add Device].

Note: There are two ways to input the serial number - scanning the QR code or manually entering the serial number.

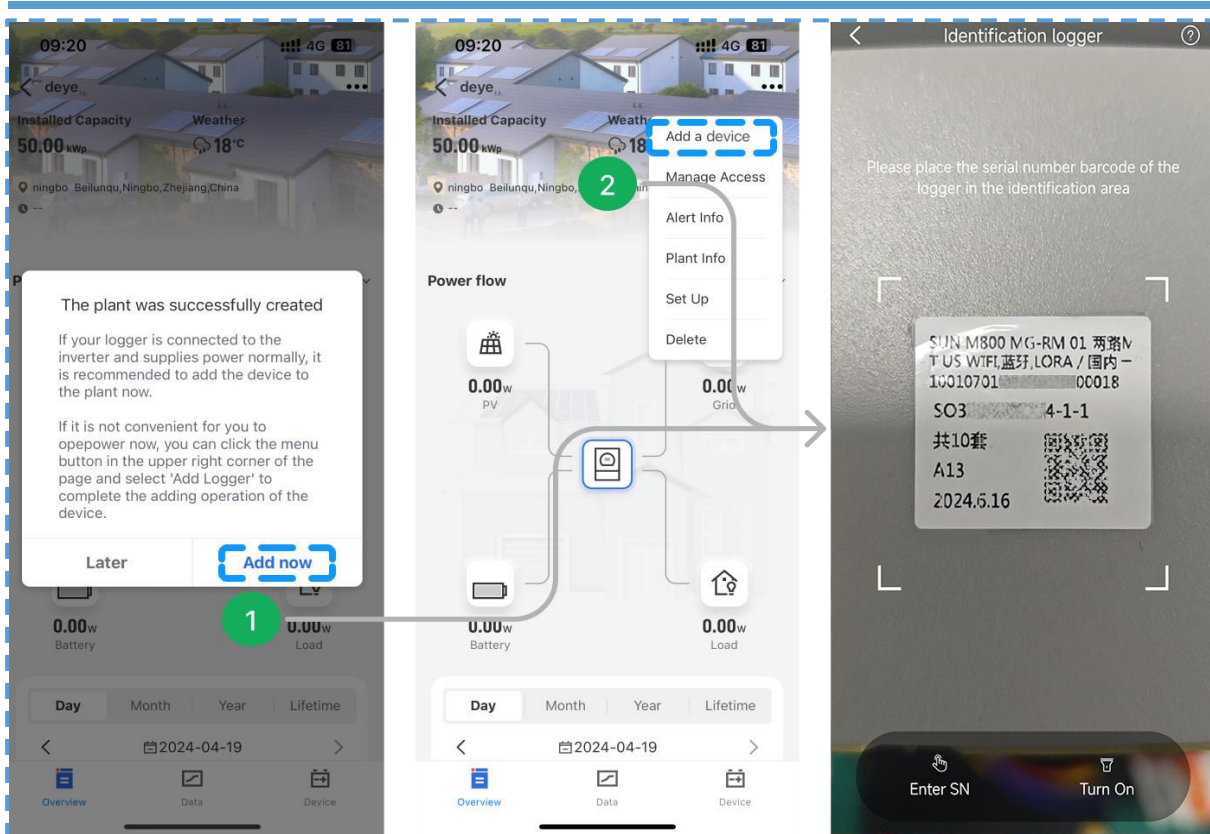

7.4 Configuration of the Network

After successfully adding the collector, please configure the Wi-Fi network for the collector to ensure the system operates correctly.

Method I: Network Configuration via Bluetooth

Step 1: Go to the configuration page for network configuration. There are two ways to access the configuration page:

- ① : Click [Add Device] under the plant list.
- ② : Click [Wi-Fi Configuration] under the “plant - device list - collector” options.

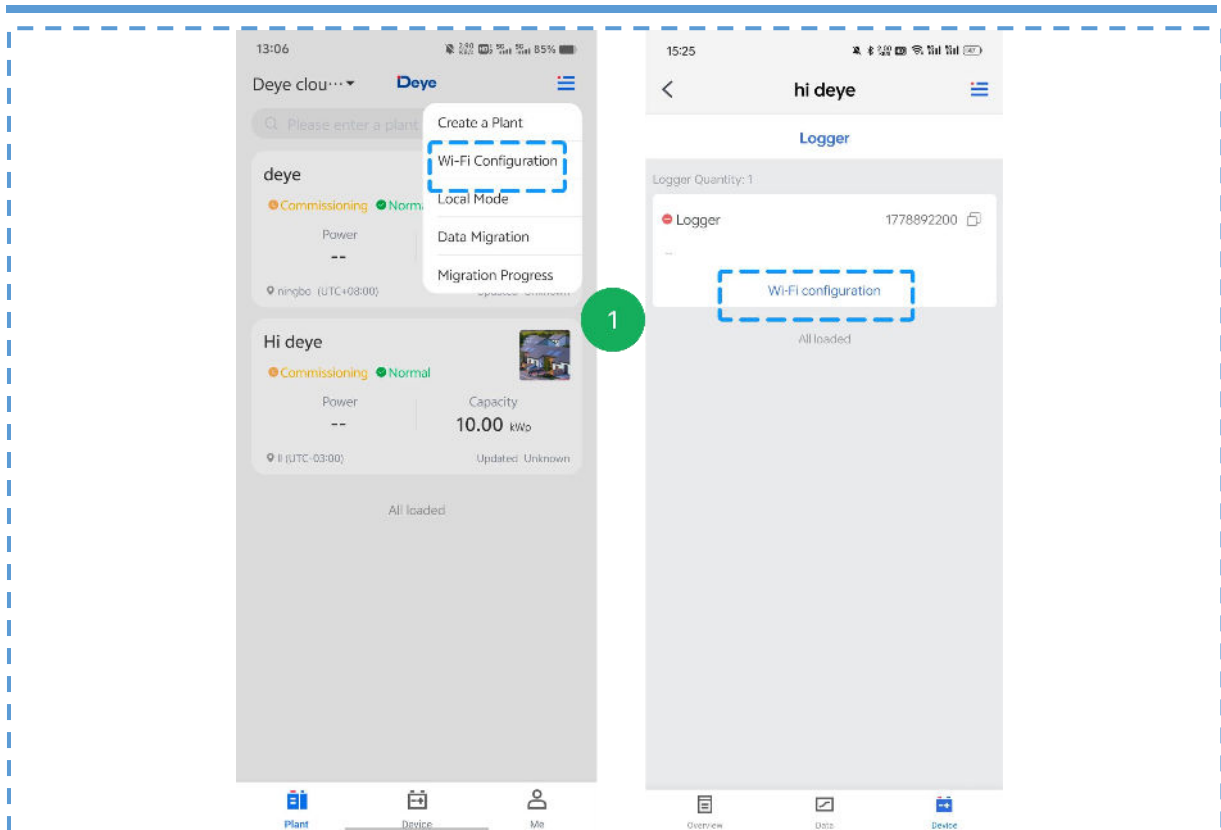

Step 2: Access the Bluetooth search interface by default. From the list of discovered devices, select the required SN.

Step 3: The system will automatically retrieve the current network connected to the phone.

You can also manually modify it. After entering the Wi-Fi password, click on [Next].

Step 4: After the network configuration is completed, you can enter a personalized name. Finally, click on [Finish] to complete the configuration.

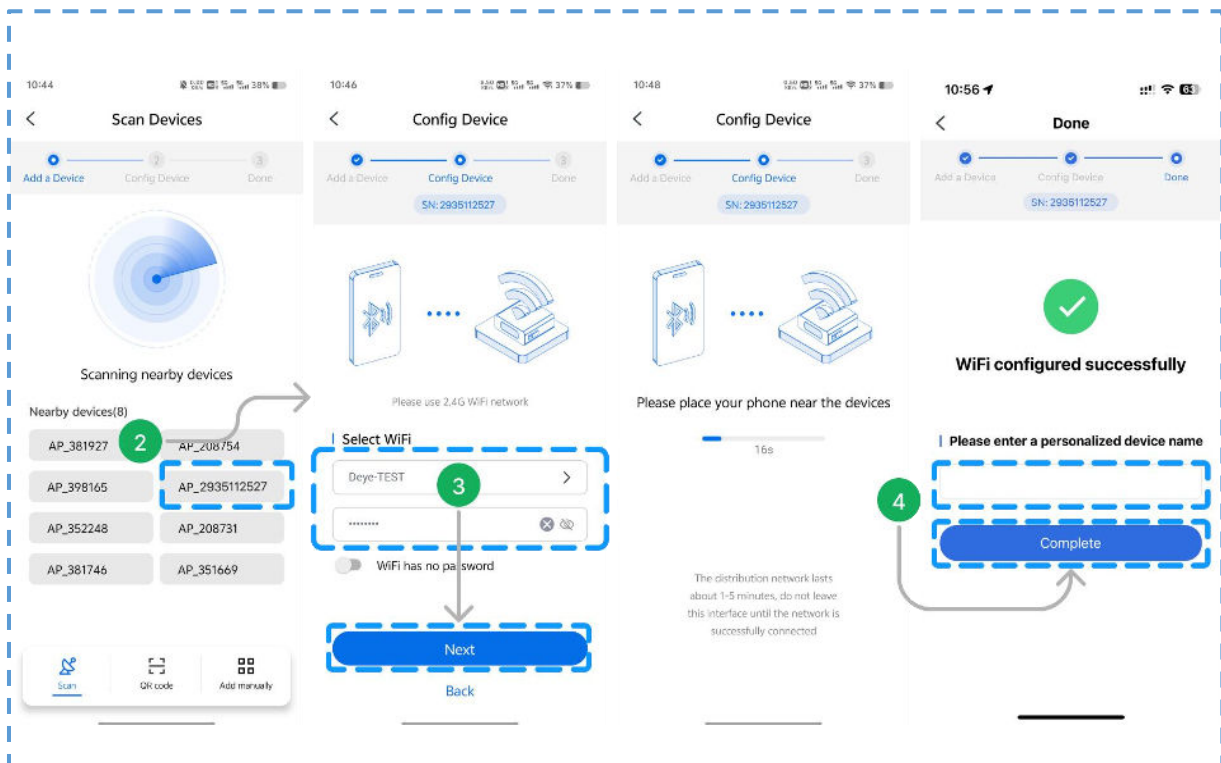

Method 2: Network Configuration via Wi-Fi

For devices that do not support network configuration via Bluetooth, the network configuration can be done by scanning the QR code or entering the collector SN.

Step 1: Click [Scan to Add] or [Manually Add] to add the device.

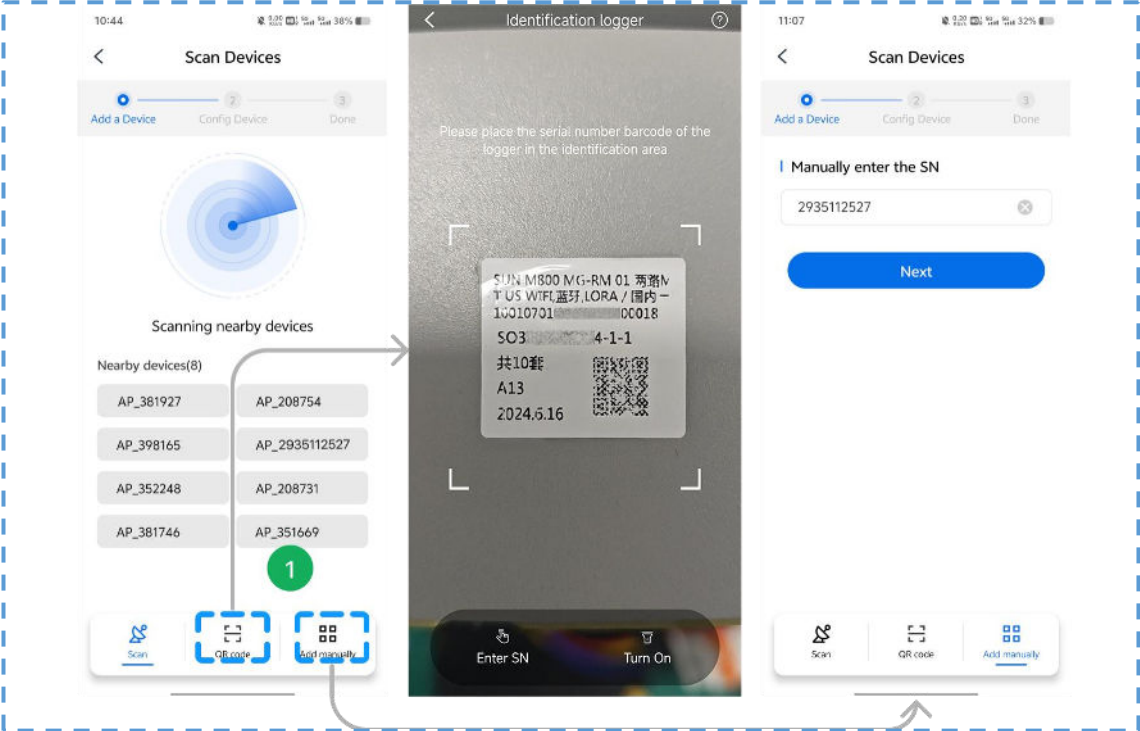

Step 2: The system will automatically retrieve the current network connected to the phone.

You can also manually modify it. After entering the Wi-Fi password, click on [Next].

Step 3: Wait for the system to perform Wi-Fi network detection.

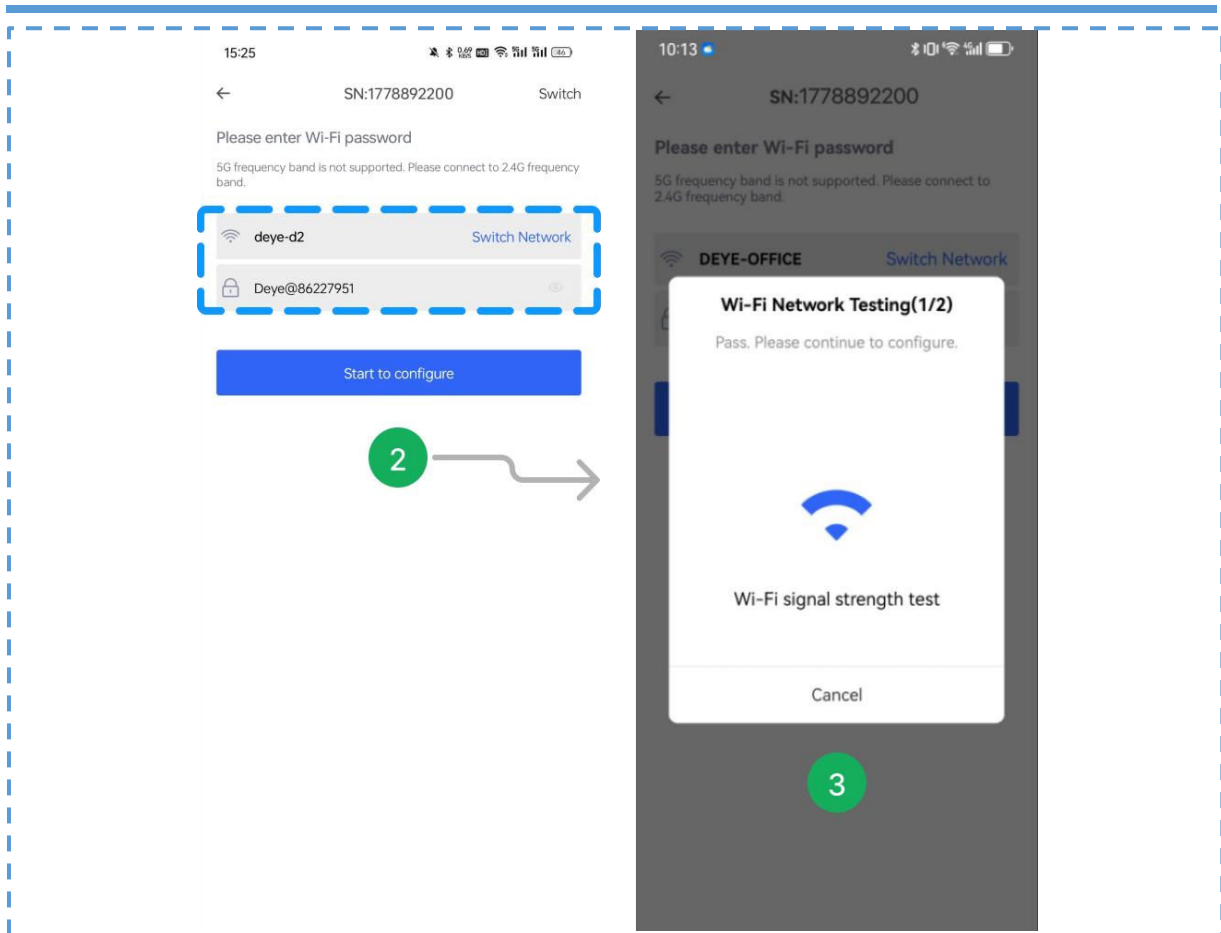

Step 4: click [Connect] to skip to the WLAN page and configure the collector.

Step 5: Select WLAN (AP+SN) prompted by the system and enter the password.

Step 6: Click [←] to return to the APP after the successful connection.

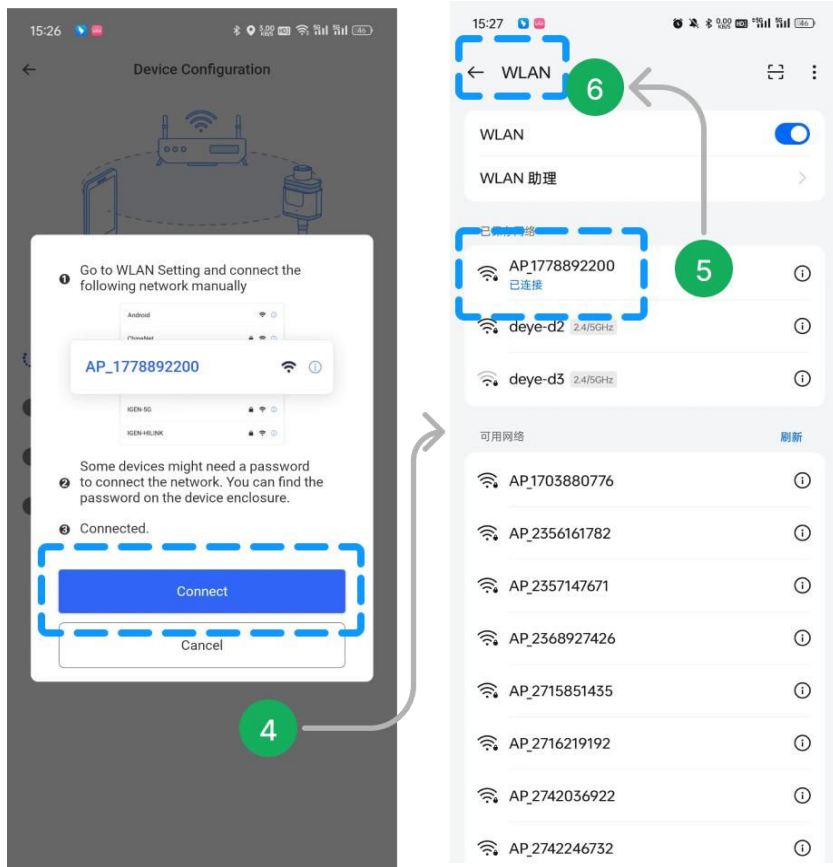

Step 7: Connect the device and wait for the configuration process, including Configuring, Restarting, and Completing Verification.

Step 8: After the "Configuration Succeeded" page is displayed, click [Complete] to close the page and complete the network configuration.

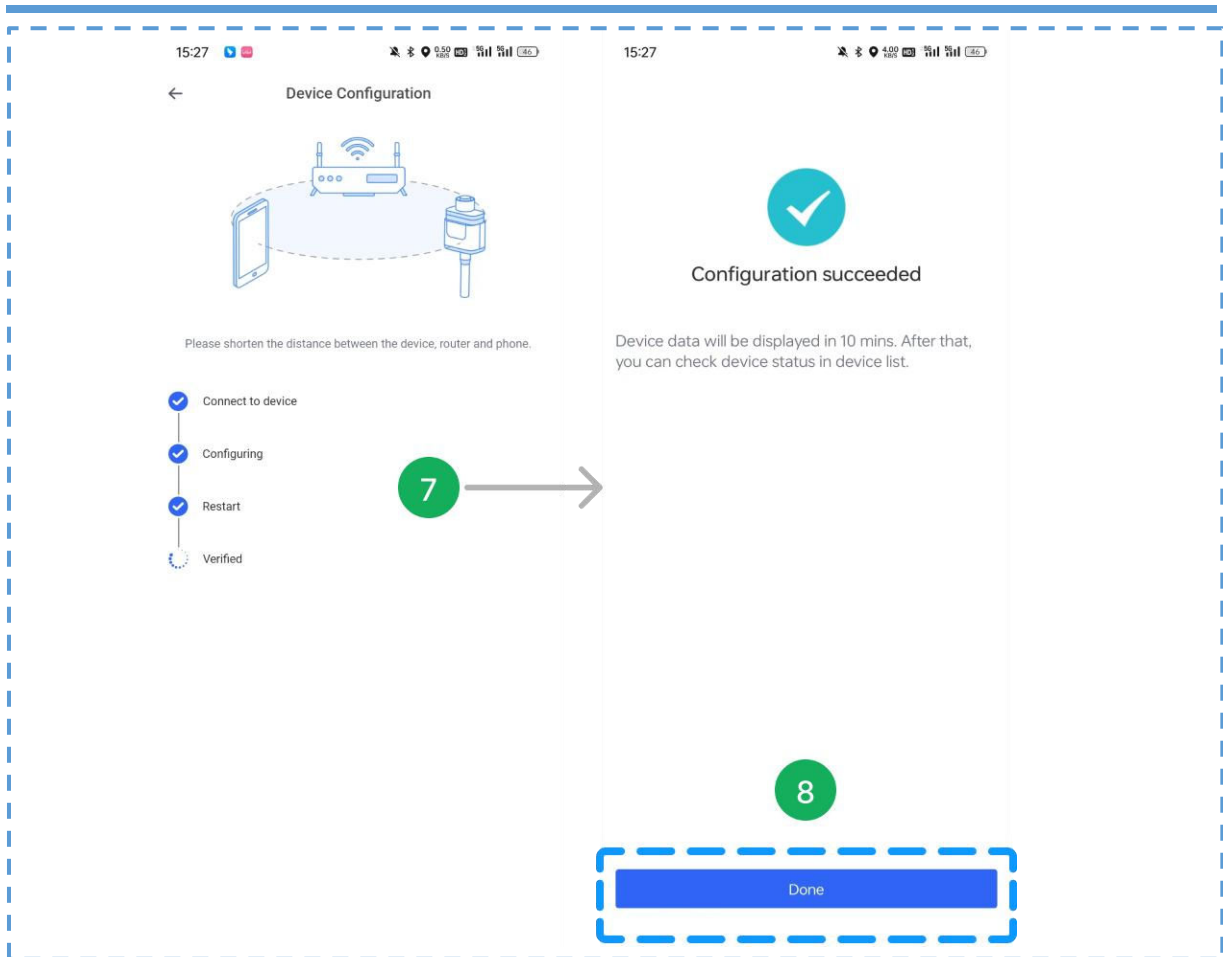

8. Use of the Extender Battery Module

The extender battery module is used in conjunction with the AE-FS2.0-2H2 Balcony Energy Storage System. Up to four extender battery modules can be connected to the system, enabling a capacity expansion by up to 8kWh to meet the user's demand for a larger battery capacity.

8.1 Parameters and Specifications of the Extender Battery module

Model	AE-F2.0
Battery Technical Specification	
Battery Chemistry	LiFePO ₄
Battery Nominal Voltage	51.2V
Battery Nominal Energy	2kWh
Max.Charging/Discharging Current	40A
Battery Operating Voltage	44.8V~57.6V
Battery Cycle Life	≥6000(@25℃±2℃, 0.5C/0.5C, 70%EOL)
Parallel Capability	5pcs
Other Technical Specification	
Display	LED(SOC, ALARM)
Communication interfaces	CAN2.0, LoRa
Dimension(W × D × H)	450 × 210 × 244mm
Weight Appr.	20kg
Operating Temperature Range	-10℃ ~ 50℃
Max.operating altitude	3000m
Relative Humidity	15% ~ 85% (No Condensing)
Certification	UN38.3, IEC62619, CE
Installation Style	Floor-Mounted

8.2 Connection Method for AE-F2.0

1. First, make sure that AE-F2.0 extender battery module and AE-FS2.0-2H2 are turned off, and open the dust covers on the connection ports.
2. Connect the AE-F2.0 extender module to the AE-FS2.0-2H2 battery system using the connecting cable. (Note: The two connection ports on AE-FS2.0-2H2 are designated for input and output, respectively. Connect the BAT-IN port of the AE-F2.0 extender module to the BAT-OUT port of the AE-FS2.0-2H2 battery system.)
3. Check if the connecting cables between the AE-F2.0 extender module and the AE-FS2.0-2H2 battery system are securely plugged in.
4. Turn on the power switch of the AE-F2.0 extender module first and check that the LED indicator lights up, then turn on the power switch of the AE-FS2.0-2H2 battery system and check that the display screen lights up. If there is no faults or alarm, the connection is successful.

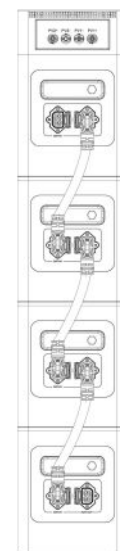

8.3 Precautions during Use

-
1. Before connecting the battery system with the extender modules, please make sure that they are all turned off.
 2. Do not connect or disconnect the extender modules during active charging or discharging . To disconnect or remove the extender modules, please first turn off the battery system and the extender modules.
 3. Please do not make physical contact with the connection joints of the extender modules with hands or any other objects. If foreign particles are found on the connection joints, gently wipe them off with a dry cloth.
 4. When connecting the extender modules, ensure that the connecting cables between the extender modules and the AE-FS2.0-2H2 battery system is inserted tightly. Failure to secure the connecting cables may result in overheating of the connection joints, affecting the system's performance. In severe cases, it could lead to a fire.

9. FAQ

Q1: What type of battery is used for the product? Is the battery safe?

The high-quality lithium iron phosphate battery is used for the product. The battery can operate safely and normally as the system is developed with multiple protection strategies which protect against scenarios of undervoltage, overvoltage, overcurrent, low temperature, and high temperature.

Q2: How to determine if the system is charging or discharging?

During charging or discharging, the LCD screen will display the remaining time while the power indication icon next to the battery percentage one starts to rotate circularly and displays the input/output power. The LED light will flash during charging and discharging.

Q3: Can the system charge and discharge at the same time?

Yes, but prolonged use in this manner may cause damage.

Q4: How to clean the product?

Please use a dry, soft, clean cloth or tissue to wipe it clean.

Q5: How to store the product?

Please cut off the power supply first, then store it in a dry, ventilated environment at a suitable temperature. Do not store the product in a damp, dusty environment at a high temperature or with high salinity, as these conditions are not conducive to the storage of the product and may cause damage to it. For long-term storage, it is recommended to discharge the battery to around 50% SOC every month, then recharge it to 100% SOC in order to extend the product's lifespan.

10. Common Faults and Troubleshooting Methods

Definitions and Solutions of Faults of the Balcony Energy Storage System		
Fault Code	Definitions	Solutions
F01	DC_Inversed Failure	/
F02	DC_Insulation_Failure	/
F03	GFDI_Failure	/
F04	GFDI_Ground_Failure	/
F05	EEPROM_Read_Failure	/
F06	EEPROM_Write_Failure	/
F07	DC/DC_Softstart_Fault	/
F08	GFDI_Relay_Failure	/
F09	IGBT_Failure	/
F10	AuxPowerBoard_Failure	/
F11	AC_MainContactor_Failure	/
F12	AC_SlaveContactor_Failure	/
F16	GFCI_Failure	/
F17	Active_Battery_Hold	/
F19	Tz_Integ_Fault	/
F21	Tz_GFDI_OC_Fault	/
F23	Tz_GFCI_OC_Fault	/
F25	Reserved	/
F26	BusUnbalance_Fault	/
F28	DCIOver_M1_Fault	/
F29	Parallel_Comm_Fault	Parallel communication error:
F31	Soft_Start_Failed	/
F36	AC_GridPhaseSeque_Fault	/
F38	Parallel_system_Stop	/
F40	Gen_OverCurr_Fault	/
F43	AC_VW_OverVolt_Fault	/
F44	AC_VW_UnderVolt_Fault	/
F49	Backup_Battery_Fault	/
F52	AC_A_InductCurr_DcHigh_Fault	/
F53	AC_B_InductCurr_DcHigh_Fault	/
F54	AC_C_InductCurr_DcHigh_Fault	/
F57	AC_BackFeed_Fault	/
F60	Gen_Volt_or_Fre_Fault	/
F61	Button_Manual_OFF	/
F62	DRMs_Stop	/
F63	Arc_Fault	/

Problem Description	Analysis Method	Measures
If the on-site low-voltage battery can not obtain fault information from the SOC indicator lights, prioritize upgrading to the latest version of the battery firmware to retrieve fault information for further analysis.		
<p>SOC fluctuations in a single battery pack system</p> <p>The SOC records on the cloud platform frequently exhibit fluctuations from SOC values above 10% to 0% or from below 90% to 100%.</p>	<ol style="list-style-type: none"> 1. Check the SOC logs to determine whether SOC fluctuations occur after reaching 0% or 100% SOC as starting points, while the current is sustained. Verify if SOC fluctuations happen during both charging to 100% and discharging to 0%, or if they only occur during charging/discharging processes. 2. If there are no fluctuations from 100% to 0% or from 0% to 100%, and if fluctuations occur only after more than 2 days without reaching full charge or full discharge; 	<ol style="list-style-type: none"> 1. If SOC fluctuations occur during both charging and discharging processes, it may indicate insufficient battery capacity. Determine if it is normal capacity degradation or abnormal capacity degradation based on the battery's usage duration. If abnormal degradation is identified, the customer should replace the battery. 2. If the fluctuations occur only during discharging and primarily happen after the battery has been idle for an extended period, it indicates that the zero drift of the battery current sampling is too significant. Customers should upgrade to a battery firmware with reduced zero drift for sampling.
<p>Mos sticking fault</p> <p>The battery displays a sticking indicator light.</p>	<ol style="list-style-type: none"> 1. Use a voltmeter to measure the voltage between P+ and P- to confirm if the voltage is around 51V, which is the battery voltage; 	<ol style="list-style-type: none"> 1. Upgrade to the latest battery firmware to clear the Mos sticking fault. <p>If there is a 51V voltage present at the P+ and P- terminals, it is necessary to replace the BMS board.</p>
<p>SOC fluctuations in multi-battery pack systems</p> <p>SOC records on the cloud platform often fluctuate from one SOC value to another, and after a certain period of time, they will return to the original value.</p>	<ol style="list-style-type: none"> 1. Verify on-site whether individual batteries frequently display a red fault indicator light; 2. Retrieve battery historical events or fault codes for further analysis; 	<ol style="list-style-type: none"> 1. Replace the problematic battery pack or handle the specific issue according to the specific fault.
<p>No communication between the battery and the inverter</p>	<ol style="list-style-type: none"> 1. Check if the Deye inverter operating mode is set to lithium battery mode. 2. Check if the communication protocol setting for the Deye inverter is 00 (CAN communication mode). 3. Verify if there are normal messages on the battery pack communication port (PCS CAN), such as 0x350, 0x351, at a baud rate of 500k. 4. Check if the inverter communication port (CAN) is properly connected to the battery pack communication port (PCS CAN) using the correct connecting wire. 5. Review the test records to see if there are any PASS records for the PCS CAN communication test. 	<ol style="list-style-type: none"> 1. Once the issue is identified as per the analysis method, proceed with the corresponding solution.
<p>The battery SOC always stops at 99% and cannot reach 100%.</p>	<ol style="list-style-type: none"> 1. Check the power distribution of the inverter and verify if the charging current is allocated at the charging end according to the charging limit current reported by the battery 	<ol style="list-style-type: none"> 1. Modify the inverter settings;
<p>Voltage/Temperature disconnection fault reported</p> <p>The battery goes into abnormal sleep mode after the red light comes on</p>	<ol style="list-style-type: none"> 1. Check if there are any loose pins in the data acquisition line connector. 2. Verify if the data acquisition wiring harness is broken. 3. Inspect the BMS board for any burnt circuit in the data acquisition circuits. 	<ol style="list-style-type: none"> 1. Replace the data acquisition line; 2. Replace BMS;
<p>MOS over-temperature fault reported</p>	<ol style="list-style-type: none"> 1. Check whether the screws of B- and P- power connectors are tightened and inspect for any loose soldering joints or disconnected pins on the terminal; 2. Inspect for any loose soldering joints or disconnected pins on the Mos. 	<ol style="list-style-type: none"> 1. Tighten the screws; 2. Replace BMS;
<p>Cell high voltage protection</p>	<ol style="list-style-type: none"> 1. Check if there are any abnormalities in the data acquisition wiring harness. 2. Measure cell voltages using a multi-meter. 3. Check the SOH of the battery pack 4. Check the historical records for instances of repeated charging with low current. 	<ol style="list-style-type: none"> 1. Replace the data acquisition line; 2. Replace BMS;
<p>Cell low voltage protection</p>	<ol style="list-style-type: none"> 1. Check if there are any abnormalities in the data acquisition wiring harness. 2. Measure cell voltages using a multi-meter. 3. Check the SOH of the battery pack 4. Check the historical records for instances of forced relay opening (cutting power) by the PCS. 	<ol style="list-style-type: none"> 1. Replace the data acquisition line; 2. Replace BMS; 3. Replace the battery pack.

Problem Description	Analysis Method	Measures
Battery pack Overvoltage protection	<ol style="list-style-type: none"> 1. Check whether the charging and discharging MOS is functioning properly 2. Check the ambient temperature of the battery pack. 3. Check if the battery pack is too old or damaged. 	<ol style="list-style-type: none"> 1. Replace BMS; 2. Replace the battery pack.
Battery pack Undervoltage protection	<ol style="list-style-type: none"> 1. Check the power supply cables between battery packs 2. Check if the battery pack is too old or damaged. 	<ol style="list-style-type: none"> 1. Replace the wiring harness. 2. Replace the battery pack.
Overcurrent protection during charging	<ol style="list-style-type: none"> 1. Check if there is any damage, loose contact, or short circuiting in the charging port or wiring. 2. Check if the BMS board is functioning properly. 	<ol style="list-style-type: none"> 1. Replace the wiring harness. 2. Replace BMS
Overcurrent protection during discharging	<ol style="list-style-type: none"> 1. Check for sudden increases in load while the battery is in use. 2. Check the SOH of the battery. Damage, aging, or faults in internal battery components may lead to an increase in internal resistance. 3. Check if the temperature of the battery pack itself and the ambient temperature are normal. 4. Check if the BMS board is functioning properly. 	<ol style="list-style-type: none"> 1. Replace BMS; 2. Replace the battery pack.
High-temperature protection during charging	<ol style="list-style-type: none"> 1. Check for instances of rapid high-current charging. 2. Check for instances of prolonged charging. 3. Check the ambient temperature of the battery pack. 4. Check if the battery pack is too old or damaged. 	<ol style="list-style-type: none"> 1. Control or reduce the charging current. 2. Ensure that the battery pack is at a reasonable ambient temperature. 3. Replace the battery pack.
Low-temperature protection during charging	<ol style="list-style-type: none"> 1. Check the ambient temperature of the battery pack. 2. Check the heating current. 	<ol style="list-style-type: none"> 1. Ensure that the battery pack is at a reasonable ambient temperature.
High-temperature protection during discharging	<ol style="list-style-type: none"> 1. Check for sudden increases in load while the battery is in use. 2. Check if the battery pack is over-discharged. 3. Check the ambient temperature of the battery pack. 	<ol style="list-style-type: none"> 1. Ensure the stability of the load connection. 2. Ensure that the battery pack is at a reasonable ambient temperature. 3. Replace the battery pack.
Low-temperature protection during discharging	<ol style="list-style-type: none"> 1. Check for instances of rapid high-current discharging. 2. Check the ambient temperature of the battery pack. 3. Check the SOH of the battery pack 	<ol style="list-style-type: none"> 1. Ensure that the battery pack is at a reasonable ambient temperature. 2. Replace the battery pack.
Protection against excessively large cell voltage difference	<ol style="list-style-type: none"> 1. Check if the voltage acquisition wiring harness is functioning properly. 2. Measure cell voltages using a multi-meter. 3. Verify if the BMS board's balancing function is normal. 	<ol style="list-style-type: none"> 1. Replace the wiring harness. 2. Replace the battery pack.
Protection against excessive temperature difference	<ol style="list-style-type: none"> 1. Check the ambient temperature of the battery pack. 2. Check the temperature acquisition wiring harness 3. Check if the battery cell is damaged. 	<ol style="list-style-type: none"> 1. Ensure that the battery pack is at a reasonable ambient temperature. 2. Replace the battery pack.
MOS high temperature protection	<ol style="list-style-type: none"> 1. Check the ambient temperature of the battery pack. 2. Check the charging and discharging currents. 	<ol style="list-style-type: none"> 1. Replace BMS
OCD1	Level 1 overcurrent protection during discharging	
OCD2	Level 2 overcurrent protection during discharging	
AFE UV	AFE undervoltage fault	
AFE OV	AFE overvoltage fault	
OCDL	Discharging overcurrent latch	
OCC	Overcurrent protection during charging	
SCD	Short circuiting protection during discharging	
SCDL	Permanent failure of discharging short circuiting latch	
AFE communication failure	<ol style="list-style-type: none"> 1. Check if there are any signs of burning on the AFE pins. 2. Check if there are any signs of burning on the BMS board. 3. Measure if the AFE communication pins have communication signal levels. 	<ol style="list-style-type: none"> 1. Restart the system 2. Replace BMS board
MOSFET short circuiting	<ol style="list-style-type: none"> 1. Check whether there is a transient overvoltage, overcurrent event, and electromagnetic interference 2. Check the temperature of the battery pack 	<ol style="list-style-type: none"> 1. Replace the BMS board
EEPROM fault	<ol style="list-style-type: none"> 1. Check if there are any signs of burning on the BMS board. 2. Check if there is electromagnetic interference in the environment. 3. Open the LAN host computer, read all BMS parameters, and check if the reading is successful. 	<ol style="list-style-type: none"> 1. If unable to read, then replace the BMS board. 2. If able to read successfully, then restart.
Internal communication failure	<ol style="list-style-type: none"> 1. Check whether the connection of the communication wiring harness is loose 2. Check whether the battery pack starts up and runs normally 	<ol style="list-style-type: none"> 1. Replace the wiring harness.

Problem Description	Analysis Method	Measures
Host address duplication	1. Check if the DI DO connections are correct.	1. Adjust the connected wiring harness. 2. Restart the master first and then restart the slave
Abnormal heating	1. Check whether the heating MOS is stuck or if it has trouble switching 2. Check whether the heating time is too long	1. Replace BMS
Pre-charge failure	1. Check if the pre-charge MOS is stuck and having trouble closing/opening properly.	1. Replace BMS
Reverse connection for charging	1. Check the positive and negative connections .	1. Reconnect the wiring harness correctly
Fuse blown fault	1. Check whether the cell voltage is greater than 4.1V 2. Check for MOS short-circuiting fault and the following faults triggered at the same time: Voltage acquisition line disconnected Temperature acquisition line disconnected AFE communication fault Temperature acquisition fault Cell voltage acquisition fault AFE fault information Charging reverse connection fault Maximum cell voltage exceeding 3.8V Cell volt high level 2 Maximum cell temperature exceeding 65°C Minimum cell temperature reaching 0°C MOS temperature exceeding 100°C	1. Replace BMS

11. After-sales Service

If malfunctions cannot be resolved by following the User Manual, please contact the dealer promptly and provide clear feedback to the after-sales personnel, including the product model, purchase date, contact number, and issue details.

1. Product warranty period: 10 years

The warranty period starts from the date of purchase by the customer. Customers are advised to keep the purchase receipts and online shopping records to refer to for the purchase date.

2. During the warranty period, if damage is caused by manufacturing processes, materials, or other non-human factors, Deye ESS will provide free repair services and replacement of parts.

3. The following conditions are not covered by the warranty:

- Unauthorized disassembly for maintenance or any other purposes;
- Malfunctions caused by human factors;
- Damage caused by force majeure, including natural disasters, lightning, and accidents;
- Appearance degradation after use;